



ST 010 101 7705



- with CASCADE structure
- 160mm projection
- fixed spout
- rectangular spray pattern with 40 individual jets
- height of mixer 108 mm
- height up to aerator 94 mm
- hole diameter valve 32 mm
- hole diameter spout 35 mm
- rosette 60 x 47 mm
- 2x screw-in M 10 x 1 pressure hose, leak-tested
- max. flow 4 l/min
- lead-free
- This product can help a building meet the requirements of Green Building Rating Systems, e.g. LEED®, BREEAM®, DGNB

| | | |
|--|-----------------------|--------------------|
|  | Brushed Platinum | ST 010 101 7705-06 |
|  | Chrome | ST 010 101 7705-00 |
|  | Brushed Dark Platinum | ST 010 101 7705-99 |

Individual components of this set

You need the following components for this set

1x 13 714 705-06



1x 20 006 705-06



1x 20 006 706-06





CL.1 Three-hole basin mixer without pop-up waste - Brushed Platinum







CL.1

ST 010 101 7705

ST 010 101 7705



- 160mm projection
- fixed spout
- rectangular spray pattern with 40 individual jets
- height of mixer 108 mm
- height up to aerator 94 mm
- hole diameter 35 mm
- 2x screw-in M 10 x 1 pressure hose, leak-tested
- 1/2" connection
- max. flow 4 l/min
- lead-free
- This product can help a building meet the requirements of Green Building Rating Systems, e.g. LEED®, BREEAM®, DGNB

| | | |
|--|-------------------------------|---------------|
|  | Brushed Platinum | 13 714 705-06 |
|  | Chrome | 13 714 705-00 |
|  | Dark Chrome | 13 714 705-19 |
|  | Brushed Champagne (22kt Gold) | 13 714 705-46 |
|  | Champagne (22kt Gold) | 13 714 705-47 |
|  | Brushed Dark Platinum | 13 714 705-99 |

ST 010 101 7705

mm [inches]

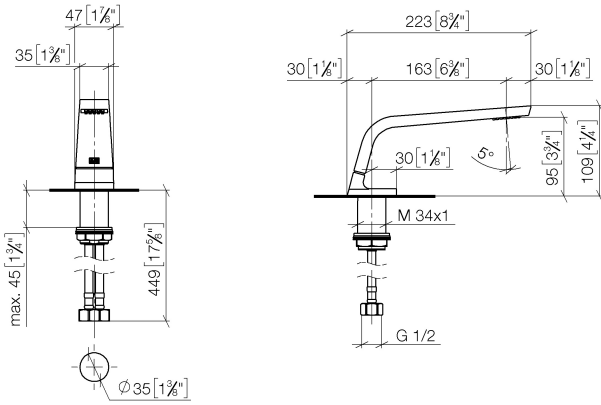

Flow rate chart

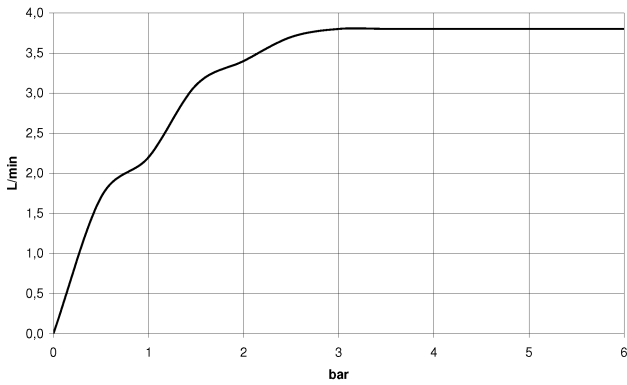

Certificates

GDV_0400279. LGA_28686. IAPMO_N-4976. IAPMO_8834 (1). IAPMO_4976 (6).

WRAS_1512011. IAPMO_6397.

ST 010 101 7705

Parts for other finishes can be found here: [Chrome](#)

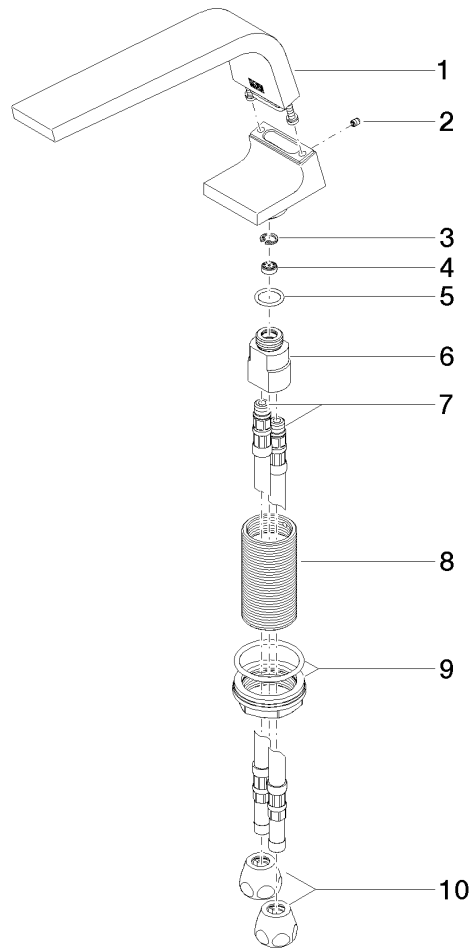







Spare parts list

| No. | Item Number | Name | Quantity used | Delivery time |
|-----|--------------------|--------------------|---------------|---------------|
| 1 | 90 11 70 002 00-06 | spout | 1 | 10 |
| 2 | 09 31 11 044 90 | pin | 1 | 2 |
| 3 | 09 16 01 016 90 | ring | 1 | 2 |
| 4 | 09 23 01 034 90 | flow reducer | 1 | 2 |
| 5 | 09 14 10 130 90 | seal | 1 | 2 |
| 6 | 09 11 10 055 10 90 | connection | 1 | 2 |
| 7 | 04 30 04 016 00 90 | hose | 2 | 60 |
| 8 | 09 30 01 208 90 | connection | 1 | 2 |
| 9 | 04 23 10 044 06 90 | fixing set | 1 | 2 |
| 10 | 90 23 30 040 00-06 | threaded connector | 2 | 10 |

ST 010 101 7705

- with CASCADE structure
- hole diameter 32 mm
- rosette 60 x 47 mm
- with cold marking



| | | |
|--|-------------------------------|---------------|
|  | Brushed Platinum | 20 006 705-06 |
|  | Chrome | 20 006 705-00 |
|  | Dark Chrome | 20 006 705-19 |
|  | Brushed Champagne (22kt Gold) | 20 006 705-46 |
|  | Champagne (22kt Gold) | 20 006 705-47 |
|  | Brushed Dark Platinum | 20 006 705-99 |



CL.1 Three-hole basin mixer without pop-up waste - Brushed Platinum

CL.1

ST 010 101 7705

ST 010 101 7705

mm [inches]

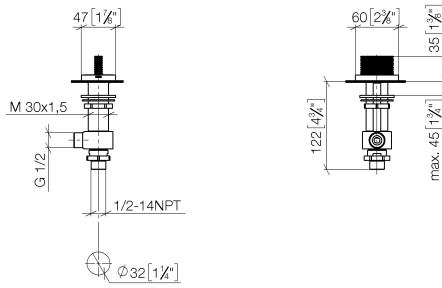

Flow rate chart



Certificates

WRAS_1804020. IAPMO_4976 (5). IAPMO_N-4976. LGA_28687. IAPMO_6397.

WRAS_240202020.

ST 010 101 7705

Parts for other finishes can be found here: [Chrome](#)

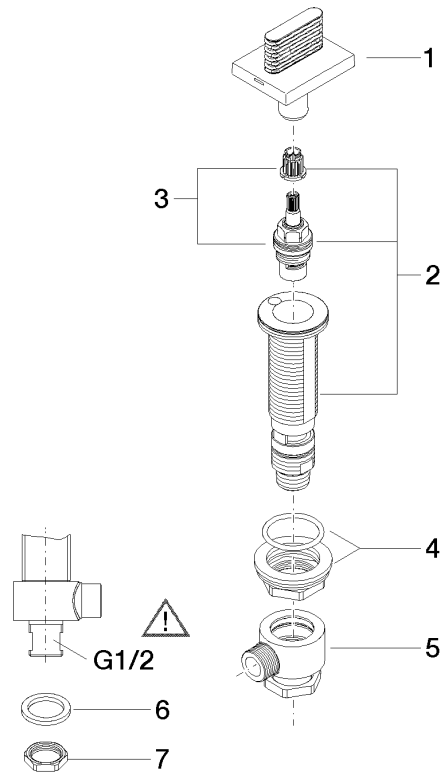







Spare parts list

| No. | Item Number | Name | Quantity used | Delivery time |
|-----|--------------------|--------------------|---------------|---------------|
| 1 | 90 20 70 053 06-06 | handle (cold) | 1 | 10 |
| 2 | 04 17 11 058 53 90 | side panel | 1 | 2 |
| 3 | 90 90 03 153 00 90 | top | 1 | 2 |
| 4 | 04 23 10 032 78 90 | fixing set | 1 | 2 |
| 5 | 04 17 11 023 10 90 | distributor | 1 | 2 |
| 6 | 90 23 30 040 00-06 | threaded connector | 1 | 10 |
| 7 | 09 30 11 059 90 | disc | 1 | 2 |
| 8 | 09 23 10 012 90 | nut | 1 | 2 |

ST 010 101 7705

- with CASCADE structure
- hole diameter 32 mm
- rosette 60 x 47 mm
- with hot marking



| | | |
|--|-------------------------------|---------------|
|  | Brushed Platinum | 20 006 706-06 |
|  | Chrome | 20 006 706-00 |
|  | Dark Chrome | 20 006 706-19 |
|  | Brushed Champagne (22kt Gold) | 20 006 706-46 |
|  | Champagne (22kt Gold) | 20 006 706-47 |
|  | Brushed Dark Platinum | 20 006 706-99 |



CL.1 Three-hole basin mixer without pop-up waste - Brushed Platinum

CL.1

ST 010 101 7705

ST 010 101 7705

mm [inches]

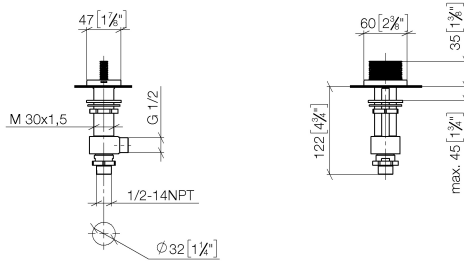

Flow rate chart



Certificates

WRAS_1804020. IAPMO_4976 (5). IAPMO_N-4976. LGA_28687. IAPMO_6397.

WRAS_240202020.

ST 010 101 7705

Parts for other finishes can be found here: [Chrome](#)

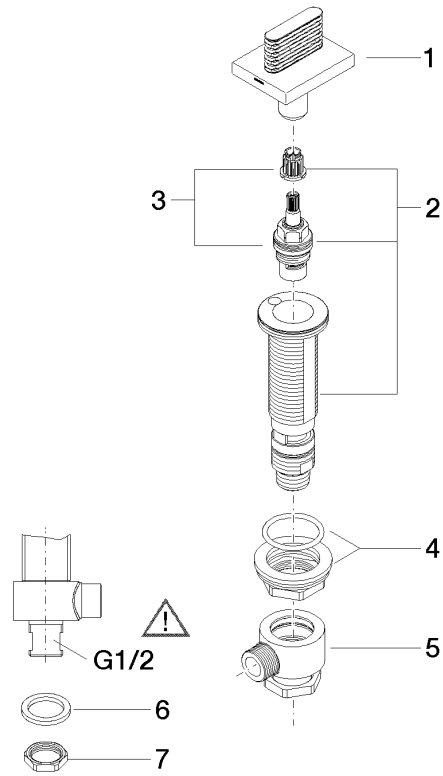

Spare parts list

| No. | Item Number | Name | Quantity used | Delivery time |
|-----|--------------------|--------------------|---------------|---------------|
| 1 | 90 20 70 053 07-06 | handle (hot) | 1 | 10 |
| 2 | 04 17 11 058 52 90 | side panel | 1 | 2 |
| 3 | 90 90 03 152 00 90 | top | 1 | 2 |
| 4 | 04 23 10 032 78 90 | fixing set | 1 | 2 |
| 5 | 04 17 11 023 10 90 | distributor | 1 | 2 |
| 6 | 90 23 30 040 00-06 | threaded connector | 1 | 10 |
| 7 | 09 30 11 059 90 | disc | 1 | 2 |
| 8 | 09 23 10 012 90 | nut | 1 | 2 |